

Cross, base, corner clamps

BETTI SISTEMI
PARTNER FOR SYSTEMS IN
FLEXIBLE AUTOMATION AND
THE SAFETY OF MACHINES

COMPANY
WITH QUALITY SYSTEM
CERTIFIED BY DNV
ISO 9001

Certificate No. SQ 1613-IT

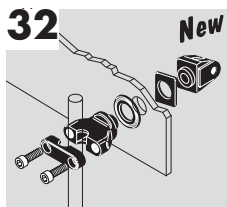
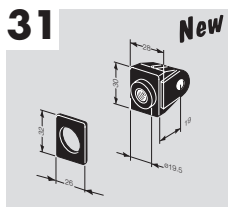
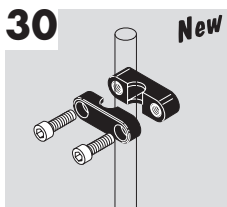
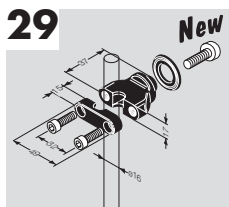
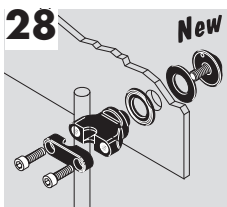
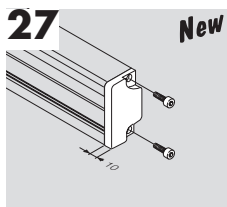
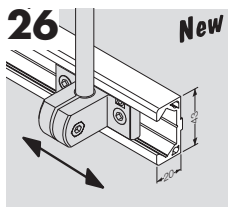
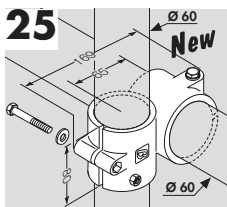
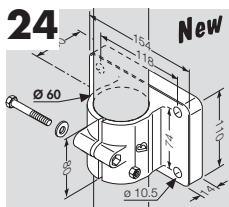
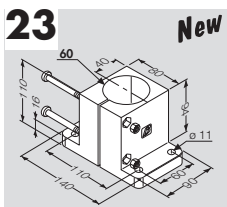
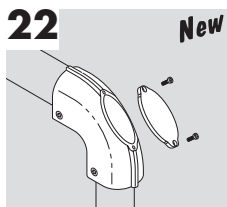
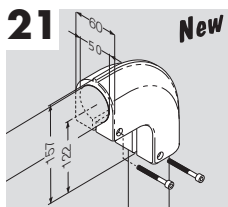
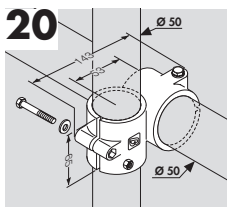
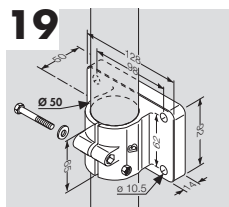
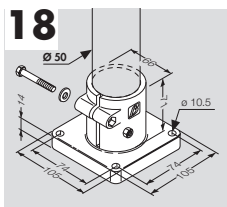
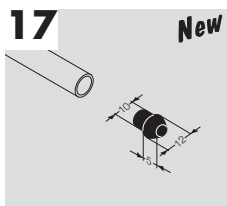
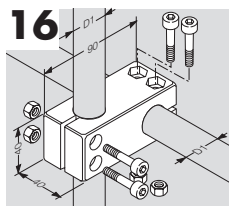
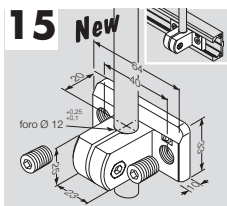
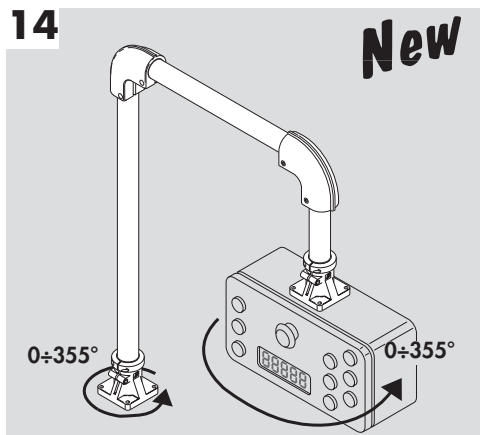
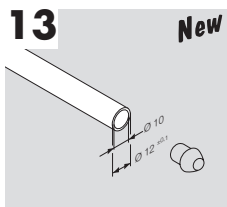
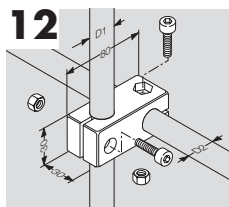
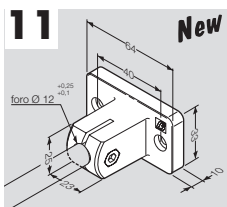
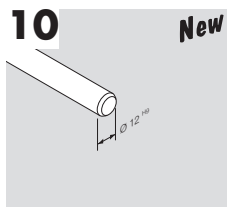
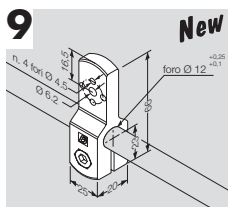
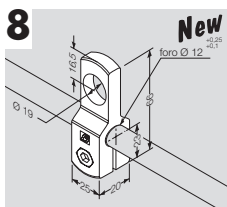
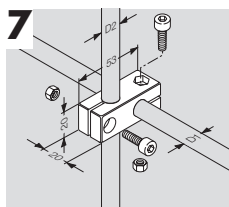
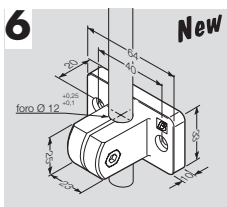
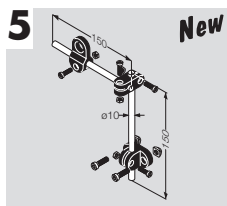
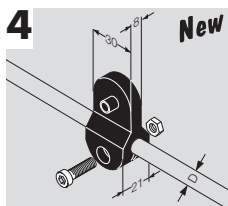
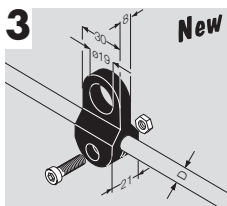
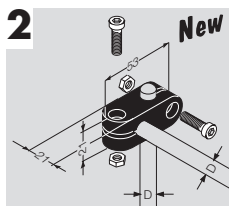
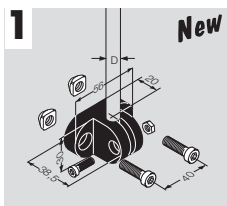

VORREI ULTERIORI INFORMAZIONI SUL PRODOTTO N° PER UNA QUANTITÀ DI PZ.

I WISH TO RECEIVE FURTHER INFORMATION ON THE PRODUCT NO. FOR A QUANTITY OF PCS.